



COWAY LOVES THE PLANET
This paper can be recycled.

COWAY

Coway Electronic Bidet BA08-AR/AE

- This product can not be used if the voltage is different from that mentioned in the rating plate.
- For your safety and proper use of the product, please read this User's Manual before use.
- Warranty card is included in this User's Manual.

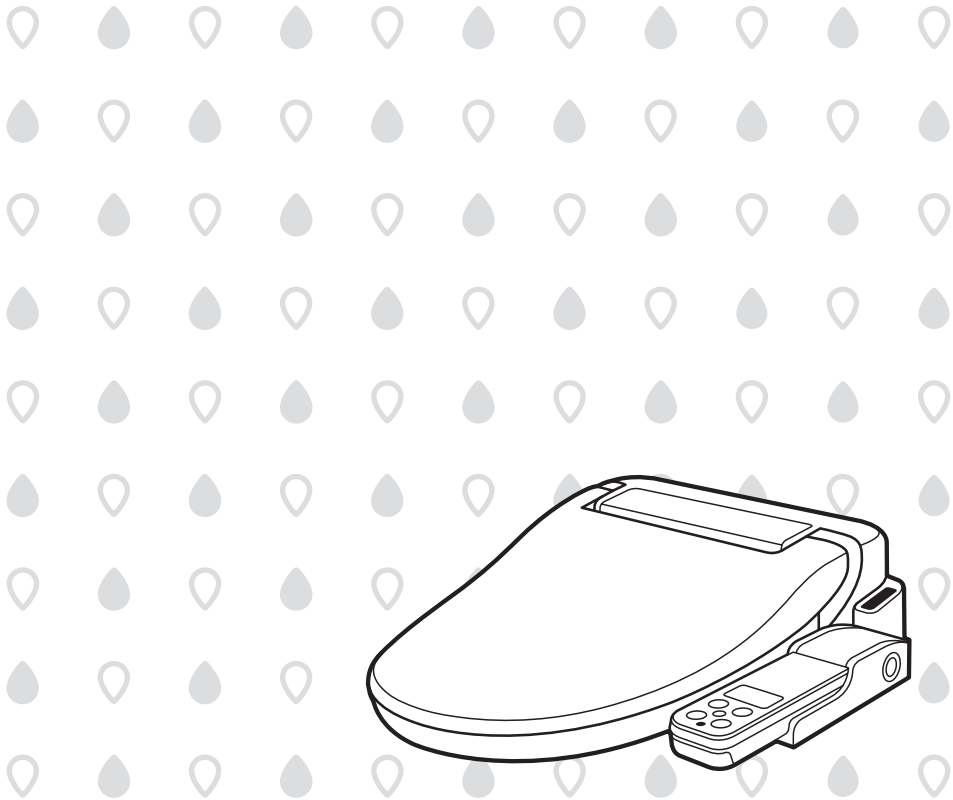

FEATURES

1. WIDE function

Users can select the degree of the cleansing water spreading directly as the wanted step from the strong force of the flowing water to the softly spreading water.



2. Air+ function

You can feel more soft and strong cleansing power as it is an air mixed water type.

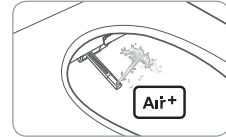

3. Special function for the customer's convenience

- **Power saving mode** : If you don't operate the bidet body/remote control button for 30 minutes without sensing the human body on the seat sensor, the body power selection indicator is turned off, and as the water/seat temperature is set as "Low" status, the amount of the power consumption is decreased.
- **Remote control power saving mode** : If you don't operate the remote control button for 30 minutes, as the remote control indicator window is turned off, the amount of the battery consumption of the remote control is decreased.
- **Silent mode** : The bell sound can be turned on/off according to customer preference.
- **Seat sensor lock mode** : As rear cleansing/front cleansing/air dryer will not work without the user sitting on the seat, it prevents the operating malfunctions due to children's unintended button inputs.

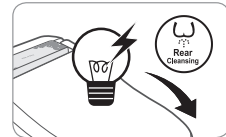

4. Auto cleansing function

With one button, you can operate the cleansing function and the drying function continuously.

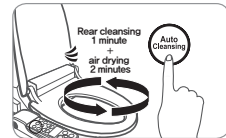

5. Nano silver ceramic MF filter

With the MF filter for the room water applied to the bidet, you can always wash with the filtered clean water.

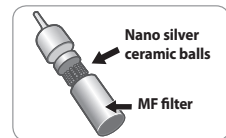

6. Twin nozzle

As the rear cleansing nozzle and the front cleansing nozzle are separated, it is a hygienic.

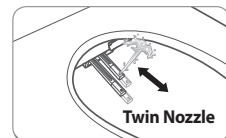

DEAR CUSTOMERS

Thank you for using our **Coway Bidet.**

Please read this User's Manual to use and maintain the product correctly.

If you encounter a problem while using the product, you may solve the problem referring to the User's Manual. As this manual contains the product warranty card, please keep it in a safe place.

CONTENTS

FOR INFORMATION

- | 03 | **IMPORTANT SAFETY GUARDS**
 - Danger
 - Warning
 - Caution
- | 07 | **PART NAMES**

MAINTENANCE

- | 18 | **INSTALLATION**
 - Uninstallation Existing Toilet Seat
 - Installation the Product
 - Installation the Remote Control Mount
 - Installation the Remote Control Wall Hanging
- | 25 | **CLEANING METHOD**
 - Nozzles
 - Product Body
 - Uninstallation the Product
- | 28 | **MAINTENANCE**
 - Freezing Protection Function
- | 29 | **FILTER REPLACEMENT METHOD**

HOW TO USE

- | 10 | **KEEP IN MIND**
- | 12 | **PREPARATIONS**
- | 13 | **OPERATION / INDICATION PART**
- | 16 | **HOW TO USE**
 - For rear cleansing
 - For front cleansing

OTHERS

- | 30 | **TROUBLESHOOTING**
- | 32 | **SPECIFICATION**
- | 33 | **WARRANTY CARD**

- Please keep the User's Manual where it can be readily reached or found. -

SAFETY PRECAUTIONS

Be careful to keep this safety information.

Please read this information to prevent property loss and ensure your safety.

▲ DANGER : If not observed, serious injury or even death may occur as a result.

- Do not use a damaged power cord or plug, and loose outlet.
- Please connect the power plug to a dedicated grounded electrical outlet.
- Do not carry the unit by its power cord.
- Do not touch the power plug with a wet hand.
- Do not forcefully bend the power cord or put it under a heavy object to prevent it from being damaged or deformed.
- Do not connect and pull out the power plug repeatedly.
- If the electric outlet is wet, carefully unplug the unit and let the electric outlet completely dry before subsequent use.
- Unplug the product before repair, inspection, or parts replacement.
- Remove any dust or water off in the pin and contacts of the power plug.
- Do not plug into an outlet that is being used by several other appliances. Use an electrical outlet dedicated.
- When you don't use for a long time, close the main water supply valve and unplug.
- Do not attempt to repair or modify the power cord at your discretion.
- In the case the power cord is damaged, do not replace the cord yourself. Call Service Center to have it replaced.
- If the steam cleaner produces a strange noise, flaming smell, or smoke, immediately unplug from the electrical outlet and call our Service Center.
- Do not insert a wire or sharp object in any gap of the product or the warm air outlet.

-
- Do not place an electric heater near the product or dispose of any flamed material such as lit cigarettes in the toilet.
 - Do not place any containers with water, medicine, food, small metallic objects, or any flammable material on the top of the product.
 - Do not use the product where excessive moisture exists or do not splash water on the product.
 - Do not use the product if it is not working properly.
 - While taking a shower or cleaning the bathroom, pull out the power plug from the electrical outlet and exercise caution not to have water or detergent splashed on the bidet.
 - Don't separate the bidet body and the bidet seat.
 - Do not disassemble, repair, or modify the product at discretion.

SAFETY PRECAUTIONS

▲ WARNING : If not observed, serious physical injury or property damage may occur as a result.

- Do not install near a heating device.
- Avoid installing the product in places where the air is damp, dust is accumulated, or water drops.
- Do not place or use the inflammable gases, nor the flammable materials near the product.
- Use tap water as a main water.
- Do not block the air dryer outlet with a hand.
- Please turn off the main water supply valve when you replace the filter.
- For children, the elderly, and those who cannot adjust the temperature themselves or with sensitive skin, set the warm water temperature and seat temperature to "Low."
- Do not use the bidet's control panel as a support or forcefully press it down.
- Do not stand or place a heavy object on the seat cover.
- If the supply cord is damaged, it must be replaced by the manufacturer, its service agent or similarly qualified persons in order to avoid a hazard.
- The new hose-sets supplied with the appliance are to be used and that old hose-sets should not be reused.
- This appliance can be used by children aged from 8 years and above.

▲ **Caution : If not observed, minor physical injury or property damage may occur as a result.**

- Don't connect the main water to the warm water pipe.
- After installation, make sure to check the water supply connections for leaks.
- Do not install the bidet in a location exposed to direct sunlight.
- Don't open/close the seat cover severely or lean.
- Exercise caution not to have urine touch nozzles, air dryer outlet, or outside surface of the product.
- If the product is not to be used for a long time, pull out the power plug from the electrical outlet, close the main water supply valve, and drain the water in the water tank.
- Don't pull out the bidet hose or the connection hose severely.
- Unplug the system before you clean it and do not splash water directly on the bidet or don't use thinner, or benzene, chemicals, or hydrochloric acid detergent.
- This appliance is not intended for use by persons [including children] with reduced physical, sensory or mental capabilities, or lack of experience and knowledge, unless they have been given supervision or instruction concerning use of the appliance by a person responsible for their safety. Children should be supervised to ensure that they do not play with the appliance.



Tips

This product is exclusively for use in a bathroom. Do not use the product for other purposes not specified in the User's Manual (for abnormal use not intended by the manufacturer).

PARTS NAME

Dimensions

The toilet dimensions must be within those shown below.
Do not install this product on a toilet that does not meet these dimensional requirements.

Round type

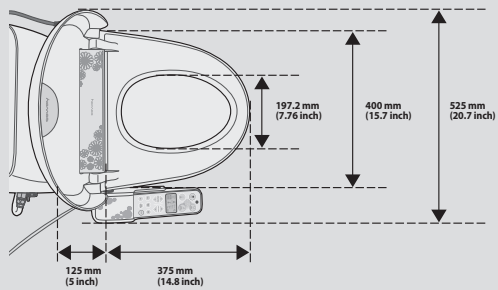

Elongate type

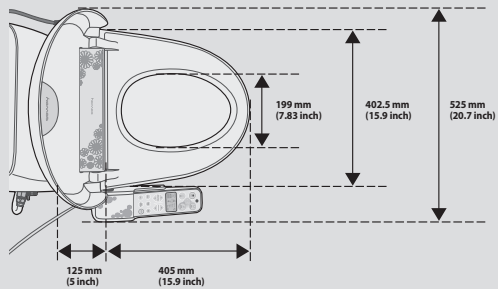

Distance of fixing hall

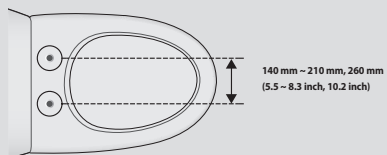

Front

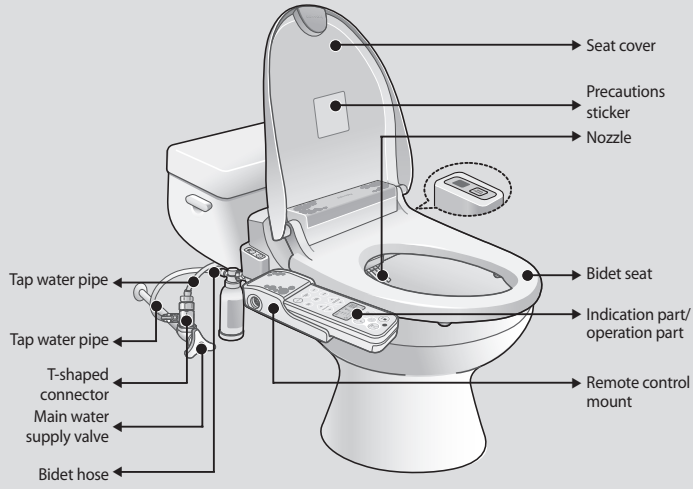

Rear

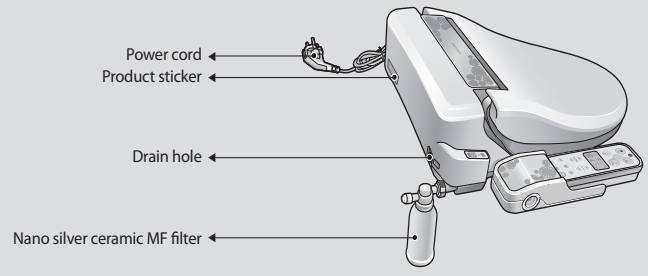

PARTS NAME

Installation material

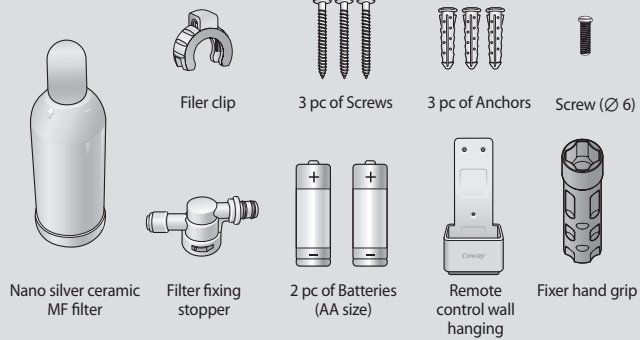
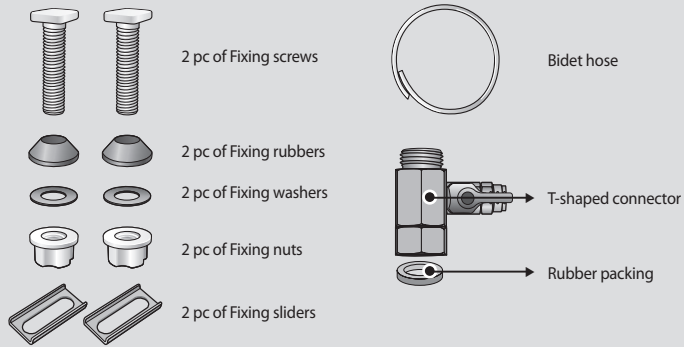

KEEP IN MIND

■ Connect the power.

Turn on the product by connecting the power plug to the electrical outlet and pressing the power selection button on the control panel.
The bidet works normally only when the electricity is connected.

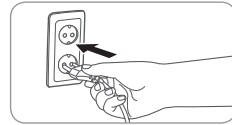

Tips

▲ This product is for 220 V – 240 V~ 50 Hz, 60 Hz only.
Please connect the power plug to a dedicated grounded electrical outlet for 220 V – 240 V~ 50 Hz, 60 Hz.

■ Open the main water supply valve.

The main water must be supplied to operate the bidet normally.

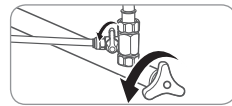

■ Check whether the product is in power saving mode before use.

- When you set the bidet body power saving mode, if there aren't a seat sensor sensing and a button operation for 30 minutes, a warm water/seat temperature operates as 'Low' status and the power save mode is kept.
- In the power save mode, the power selection indicator is turned off.
- When you sit on the bidet seat or press the button on the control panel, a power selection indicator is turned on and the water/seat temperature is operated as the last setting.
- If you sit on the bidet seat or the power selection indicator doesn't be turned on even if you press the button on the control panel, as the power is turned off, use after pressing the power selection button and turning on the power.

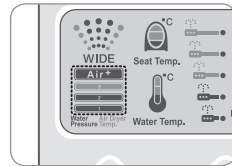

Setting Special Mode

■ Setting/canceling power saving mode

- 1) Turn on the remote control by pressing the power selection button on the remote control with pulling out the power plug, and plug in the power plug with pressing the rear cleansing function selection button of the bidet body (Alarm).
 - The alarm rings 1 time (ding) : It means the release of the bidet body power save mode.
 - The alarm rings 2 times (ding ding) : It means that the bidet body power saving mode was set.
- 3) When you select the wanted status and press the air dryer function selection button on the remote control, the selected setting is saved and it is switched to the waiting status (The alarm rings three times (ding ding ding)).

■ Setting/canceling seat sensor lock mode



- 1) Turn on the remote control by pressing the power selection button on the remote control with pulling out the power plug, and plug in the power plug with pressing the rear cleansing function selection button of the bidet body (Alarm).
 - The alarm rings 1 time (ding) : It means the release of the seat sensor lock mode.
 - The alarm rings 2 times (ding ding) : It means that the seat sensor lock mode was set.
- 3) When you select the wanted status and press the air dryer function selection button on the remote control, the selected setting is saved and it is switched to the waiting status (The alarm rings three times (ding ding ding)).

KEEP IN MIND

■ Setting/canceling silent mode

- 1) Turn on the remote control by pressing the power selection button on the remote control with pulling out the power plug, and plug in the power plug with pressing the rear cleansing function selection button of the bidet body (Alarm).
- 2) Press the stop button on the remote control and select the desired status.
 - The alarm rings 1 time (ding) : It means the release of the silent mode.
 - The alarm rings 2 times (ding ding) : It means that the silent mode was set.
- 3) When you select the wanted status and press the air dryer function selection button on the remote control, the selected setting is saved and it is switched to the waiting status (The alarm rings 3 times (ding ding ding)).

■ Setting/canceling remote control power saving mode

- 1) With the remote control turned on, press and hold the nozzle position   button for 5 seconds or more (The LCD screen blink).
- 2) When the nozzle position indicator is lightened on LCD screen, it means that the remote control power saving mode is set, and when it is turned off, it means that mode is released (See the following figure).
- 3) When you press any button on the remote control, it is switched to the waiting status with saving the setting.
 - ▶ With power saving mode on, the batteries on the remote control last longer.
 - ▶ The product is supplied with the remote control power saving mode set.

Power saving mode set screen

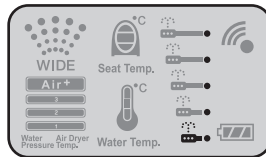

Power saving mode canceled screen

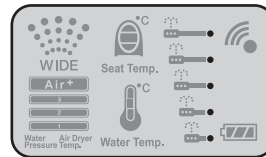

Tips

- ▶ When you press the power selection button on the remote control, the powers on the remote control and bidet body are operated simultaneously (But the button in the bidet body work regardless of the remote control).
- ▶ When the bidet body power selection indicator doesn't turn on even if you sit on the bidet seat, as the power is turned off, turn on by plugging in the power plug and pressing the power selection button.

PREPARATIONS



Tips

- ⚠ **This product is for 220 V – 240 V~ 50 Hz, 60 Hz only.**
Please connect the power plug to a dedicated grounded electrical outlet for 220 V – 240 V~ 50 Hz, 60 Hz .



■ After installation

Check if there is a leak in the main water supply valve and the connection hose. You must insert the rubber packing between the T-shaped connection pipe and the main water supply valve.



■ Periodic filter replacement

It is important to replace the filter periodically for the clean rinsing. If the filter is overused beyond its service life, the filter performance deteriorates, resulting in cleansing water that is not filtered properly. Please keep the filter replacement cycle.

* **Filter replacement cycle : Every 4 months**

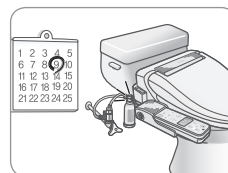

■ If the bidet has not been used for a long time

When you don't use the product for a long time, use it after replacing the filter and cleaning the products such as an air dryer outlet, a nozzle, seat according to each cleaning methods (See P.25).

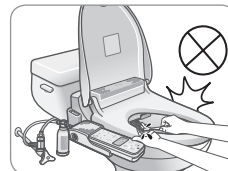

Tips

- ▶ If there is a foreign material or a water drop on the signal transmitter of the remote control or on the signal receiver of the control panel of the bidet's remote control, the remote control communication may be inhibited.
- ▶ The remote control may not work properly where there is strong light such as three-wavelength lamp light or strong electromagnetic waves are created.
- ▶ Remove the protective film from the control panel before use.

OPERATION / INDICATION PART

Remote Control Indication Part /Operation Part

● Indication part ■ Operation part

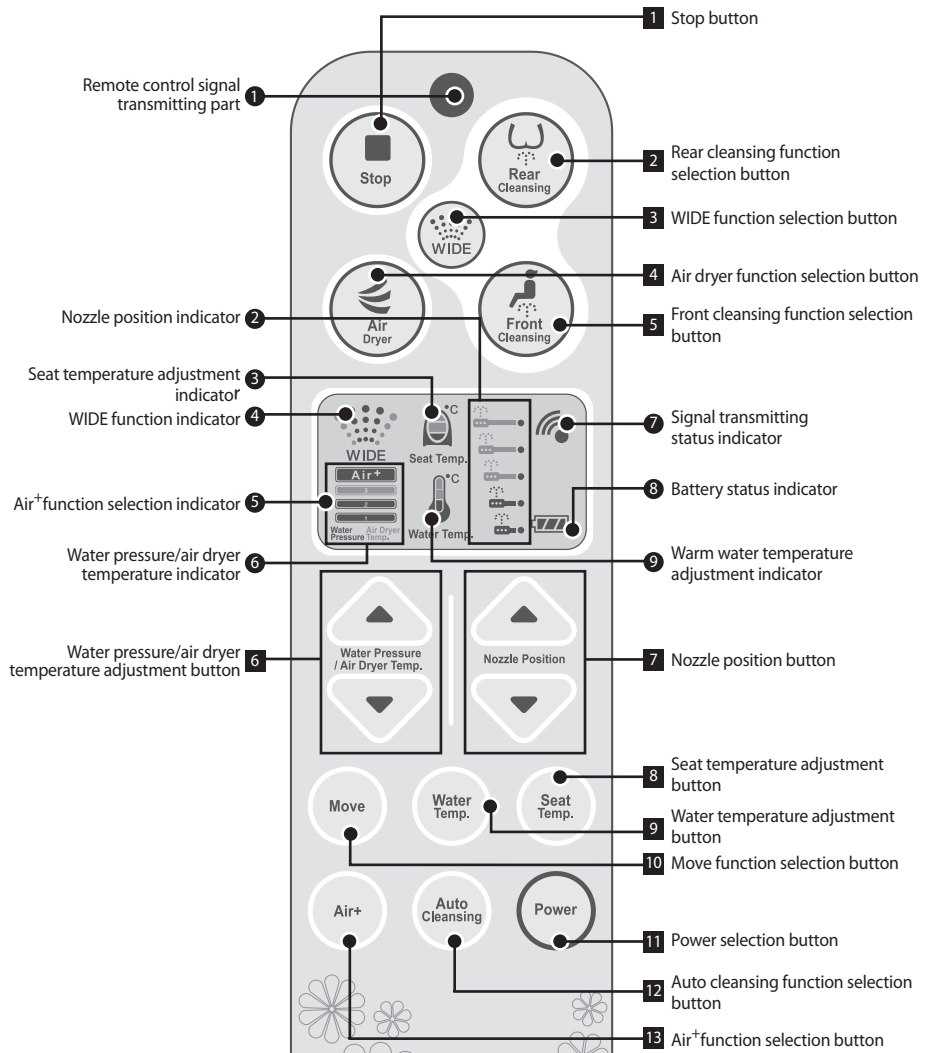

Indication Part

- 1 **Remote control signal transmitting part**
It is the transmitting window that transmits signals when the remote control buttons are pressed.
- 2 **Seat temperature adjustment indicator**
When you press the seat temperature adjustment button, you can adjust the indicator (L → M → H → Off).
- 3 **Air+ function selection indicator**
When you press Air+ function selection button, the indicator is turned on.
- 4 **Signal transmitting status indicator**
It indicates that you transmit the signal.
- 5 **Battery status indicator**
The battery status indicator is turned off and on and it notifies the battery replacement time.



- 2 **Nozzle position indicator**
If you press the nozzle position button, the lamp is turned on in 5 steps.
- 4 **WIDE function indicator**
When you press the WIDE function selection button, the indicator is turned on (Straight line → Step1 → Step2).
- 6 **Water pressure/air dryer temperature indicator**
If you press the water pressure/the air dryer temperature adjustment button, the temperature lamp is turned on in the step1 → step2 → step3 order.
▶ It is used as the water pressure adjustment indicator when you operate the front cleansing/rear cleansing function, and it is used as the water temperature adjustment indicator when you operate the air dryer function.
- 9 **Warm water temperature adjustment indicator**
When you press the warm water temperature adjustment button, you can adjust the temperature lamp (L → M → H → Off).

Operation Part

- 1 **Stop button**
Stops all operating functions.
- 2 **Rear cleansing function selection button**
Use it to select the desired rear cleansing function.
- 3 **WIDE function selection button**
Use it if you want to control the water spraying range when you use the rear cleansing function. You can select the range of the force of the flowing water of 3 steps in straight line → Step1 → step2 order using WIDE function selection button. Whenever you press the button, the indicator of the selected current spraying range is turned on.
- 4 **Air dryer function selection button**
Use it to select the air dryer function. It helps dry the wet after using the front cleansing/rear cleansing function.
- 5 **Rear cleansing function selection button**
Use it to select the cleansing function for woman.
- 6 **Water pressure/air dryer temperature adjustment button**
If you press the water pressure/the air dryer temperature adjustment button, the temperature lamp is turned on in the step1 → step2 → step3 order and 3 steps water pressure/air dryer adjustment can be performed.
- 7 **Nozzle position button**
Use when you want to adjust the nozzle position during the operation of the rear cleansing/front cleansing function. When you press the nozzle position button, you can adjust the nozzle position as 5 steps.
- 8 **Seat temperature adjustment button**
Use it when you want to adjust the toilet seat temperature. When you press the seat temperature adjustment button, you can adjust the seat temperature (L → M → H → Off).
▶ You can adjust the seat temperature regardless of the operation of other function.
- 9 **Water temperature adjustment button**
Use it when you want to adjust the water temperature. When you press the water temperature adjustment button, you can adjust the water temperature (L → M → H → Off).
- 10 **Move function selection button**
Use it to select the movie function. When you press the move function selection button, as the nozzle is moved front and rear while you operate the front cleansing/rear cleansing function, you can clean the more wide areas.
- 11 **Power selection button**
Use it to turn the remote control and the product ON/OFF.
▶ When you press the power selection button during the front cleansing/rear cleansing/auto cleansing function operation, the function only stop and the power isn't turned off.
- 12 **Auto cleansing function selection button**
Use it to select the auto cleansing function. When you press the auto cleansing function selection button, the rear cleansing 1 minute, the air dryer 2 minutes is operated successively.
- 13 **Air+ function selection button**
Use it to select Air+ function. When you press Air+ function selection button, as the air is mixed with the cleansing water during the rear cleansing/front cleansing function operation, it can clean with the more soft and strong force of the water.
▶ You can select the Air+ function regardless of the operation of other function.

OPERATION/INDICATION PART

Product Indication Part/Operation Part

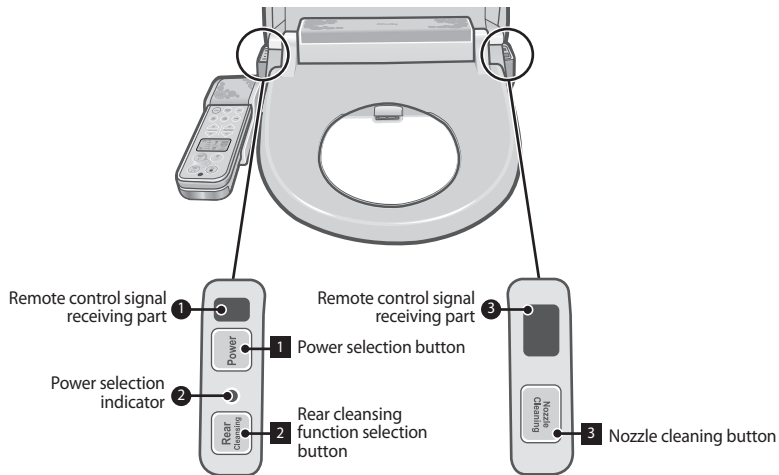

Indication Part

1 Remote control signal receiving part
It receives the signals from the remote control.

2 Power selection indicator
When the power is turned on, the indicator is lightened.
▶ When you heat the water, the power selection indicator is turned on and off.
▶ If the power selection indicator is turned on and off with the alarm, as it notifies the product abnormality, please pull out the power plug and call the service center.

3 Remote control signal receiving part
It receives the signals from the remote control.

Operation Part

1 Power selection button
Use it to turn the remote control and the product ON/OFF.
▶ When you press the power selection button during the front cleansing/rear cleansing/auto cleansing function operation, the function only stop and the power isn't turned off.

2 Rear cleansing function selection button
Use it to select the rear cleansing function.

3 Nozzle cleaning button
Use it when you want to clean the nozzle.
If you press the nozzle cleaning button, as the nozzle come forth and stop, you can clean conveniently (See P.26).

HOW TO USE

For rear cleansing

■ Rear cleansing

Sit on the seat and press the rear cleansing function selection button on the remote control.

The rear cleansing nozzle will remove the cold water remaining

- inside the nozzle before the water stream is ejected so that you can have rear cleansing with water set to a desired temperature.

- The cleansing water is ejected for about 1 minute and then automatically stopped.

- An automatic nozzle cleaning is performed for about 5 seconds after cleansing when the nozzle retracts itself.

* **Adjust the nozzle position by pressing the nozzle position \triangle / ∇ button.**

* **Press the wide function selection button to adjust the desired water ejection range.**

* **You can select the air mixed water type by pressing Air+ function selection button.**

* **If the rear cleansing function selection button is pressed again while in cleansing operation, additional rear cleansing starts again for another 1 minute.**

* **While in cleansing, users can adjust the water temperature, water pressure, and nozzle position according to their preference.**



■ Move

Press the move function selection button on the remote control.

- The nozzle moves back and forth, providing a wider range of cleansing.

* **It will be worked continuously while the cleansing function is operated.**

* **You can adjust the nozzle position by pressing the nozzle position \triangle / ∇ button.**

* **To stop the move function, press the move function selection button again.**

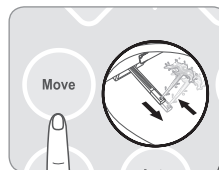

■ Air dryer

Press the air dryer function selection button on the remote control.

- Warm air blows for about 2 minutes to dry the wet part.

* **If you wipe out the wet before turning on the air dryer function, you can finish drying faster.**

* **You can adjust the air dryer temperature by pressing the water pressure/air dryer \triangle / ∇ buttons.**

* **If the air dryer function selection button is pressed again while in drying operation, additional drying starts again for another 2 minutes.**

* **If the air dryer function selection button is pressed while in cleansing operation, the cleansing function is stopped and drying starts immediately.**

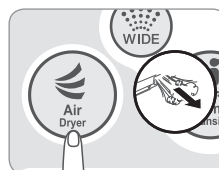

■ Stop

If you want to stop the operation in use, press stop button.

- It stops all operating functions.

* **The air dryer function is stopped in 2 seconds after pressing the stop button.**

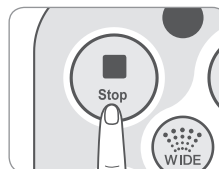

HOW TO USE

For front cleansing

■ Front cleansing

Sit on the seat and press the front cleansing function selection button on the remote control.

- The front cleansing nozzle will remove the cold water remaining inside the nozzle before the water stream is ejected so that you can have front cleansing with water set to a desired temperature.
- The cleansing water is ejected for about 1 minute and then automatically stopped.
- An automatic nozzle cleaning is performed for about 5 seconds after cleansing when the nozzle retracts itself.

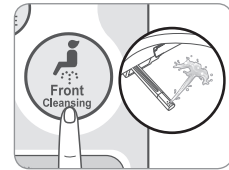

- * **Adjust the nozzle position by pressing the nozzle position \triangle ∇ button.**
- * **Press the wide function selection button to adjust the desired water ejection range.**
- * **You can select the air mixed water type by pressing Air+ function selection button.**
- * **If the front cleansing function selection button is pressed again while in cleansing operation, additional front cleansing starts again for another 1 minute.**
- * **While in cleansing, users can adjust the water temperature, water pressure, and nozzle position according to their preference.**

■ Move

Press the move function selection button on the remote control.

- The nozzle moves back and forth, providing a wider range of cleansing.

- * **It will be worked continuously while the cleansing function is operated.**
- * **You can adjust the nozzle position by pressing the nozzle position \triangle ∇ button.**
- * **To stop the move function, press the move function selection button again.**

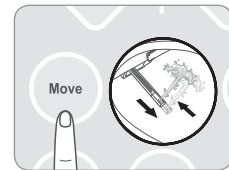

■ Air dryer

Press the air dryer function selection button on the remote control.

- Warm air blows for about 2 minutes to dry the wet part.

- * **If you wipe out the wet before turning on the air dryer function, you can finish drying faster.**
- * **You can adjust the air dryer temperature by pressing the water pressure/air dryer \triangle ∇ buttons.**
- * **If the air dryer function selection button is pressed again while in drying operation, additional drying starts again for another 2 minutes.**
- * **If the air dryer function selection button is pressed while in cleansing operation, the cleansing function is stopped and drying starts immediately.**

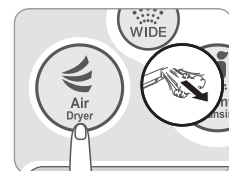

■ Stop

If you want to stop the operation in use, press stop button.

- It stops all operating functions.

- * **The air dryer function is stopped in 2 seconds after pressing the stop button.**



INSTALLATION

■ Installing the product

Tighten the fixing nuts firmly so that the bidet body won't be shaky on the toilet.

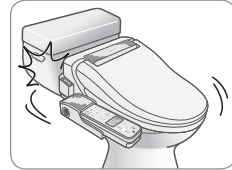

■ Product installation place

As the bidet should be installed on the toilet, take caution not to have water splashed on the bidet.



■ After installation

Keep the removed existing toilet seat in a shaded place to prevent its damage.

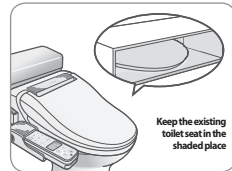

■ Cold water pipe

Please connect to the cold water pipe (If the product is connected to the warm water pipe, the filter and hose may be damaged).

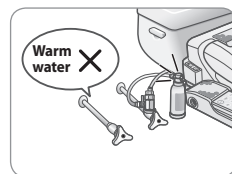

Tips

- ▶ To maintain the optimal product performance, consult a Coway engineer for detailed installation methods.
- ▶ There may be some water remaining inside the filter which was used to test the product during the inspection process at the factory.
- The remaining water does not mean that the product was previously used.

INSTALLATION

Uninstallation Existing Toilet Seat

1. Remove the fixing nuts of the existing seat and separate the existing toilet seat ① and the seat cover ②.

* Keep the removed seat and the removed seat cover in a shaded place.

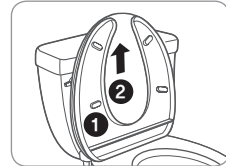

Installation the Product

1. Turn off the main water supply valve ① on the water pipe and separate the existing water tank hose ②.

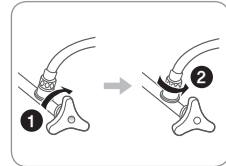

2. Connect the rubber packing, T-shaped connector, and water tank hose to the existing tap water pipe. Please connect the bidet hose to the T-shaped connector.

* Please insert the rubber packing between the water pipe and the T-shaped connection pipe necessarily.

* Firmly rotate the nuts below and on top of the T-shaped connector to the end clockwise.

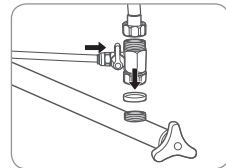

3. Please assemble by turning the MF filter on the filter holder to the arrow direction as the figure.

* If the filter is assembled loosely, the bidet may not function normally. Firmly connect the filter.

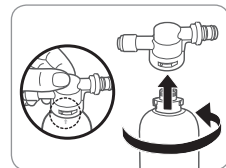

4. Please connect the filter assembled the filter holder in the rear of the product and fix using the filter clip.

⚠ Check if the filter clip is inserted correctly. When the main water supply valve is opened, if the filter clip is loosely fitted, as the filter holder may be separated, the water may splash and it may cause injury.

⚠ It is not possible to separate the filter clip once it is fitted to the product. When the problem occurs due to the filter clip, call the service center.

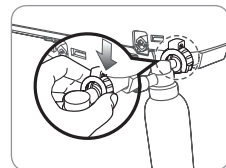

NOT ENOUGH SPACE TO INSTALL FILTER?

If there is not enough space to install filter at the rear of your bidet, use connector filter to install from a different direction.

5. Connect connector filter with the main body of bidet.

- Insert the connector filter into the water tank pipe that is placed in the bottom left of the main body.

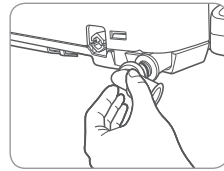
**6. Insert plastic clip filter to prevent the connector filter from disjunction with the water tank pipe.**

- ⚠ **Make sure the plastic clip filter is completely inserted. If it is not, it may cause the tap water leakage or damage when opening the water supply valve.**
- ⚠ **Plastic clip filter can not be separated. If there is a problem, please contact to the after service center.**

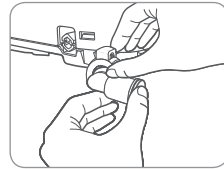
**7. Connect filter with connector filter.**

- * **Screw while turning the filter to connect with the holder filter.**
- * **Insert the holder filter into the Connector filter.**

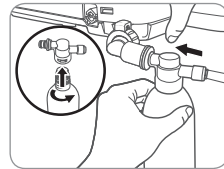
**8. Insert plastic clip filter for the tight connection between the holder filter and connector filter.**

- ⚠ **Make sure the plastic clip filter is completely inserted. If it is not, it may cause the tap water leakage or damage when opening the water supply valve.**
- ⚠ **Plastic clip filter can not be separated. If there is a problem, please contact to the after service center.**

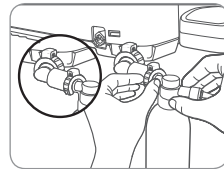

INSTALLATION

Installation the Product

9. Push fixing screw into the fixing slider. And slide the fixing slider with fixing screw to be hooked in the installation board.

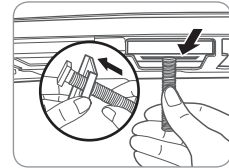

10. Insert fixing screw into the holes and push fixing rubber, fixing washer into the fixing screw to prevent from wobbling of the main body. Then tighten up the fixing nuts.

⚠ If you do not tighten nuts. It may cause injury or damage to customer.

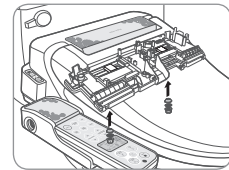

11. Please connect the bidet hose to the filter fixing stopper.

*** Please shorten the bidet hose as soon as possible. If the bidet hose is long, it may cause noises.**

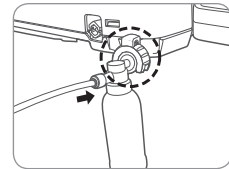

12. Open the main water supply valve.

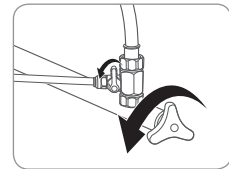

13. Connect the power plug to the electrical outlet.

*** Make sure to use a grounded electrical outlet. In the case of short circuit, grounding prevents electric shock or injury.**

⚠ Make sure to use a dedicated electrical outlet with grounding terminals.

⚠ If it is unavoidable to use an extension cord, use one with grounding terminals for power rating of 250 V / 7 A or higher.

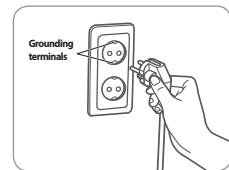

**Tips**

► This installation method was explained on the basis of the case installed the remote control mount for the right hand.

► After removing the fixing screw and separating the product from the toilet, separate and install the remote control mount.

Installation the Remote Control Mount

1. Remove the fixing screw (Ø 6) that fixes the remote control mount on the bottom of the bidet.

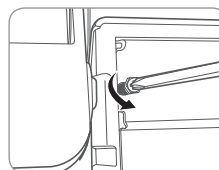

2. Remove the remote control mount from the bidet.

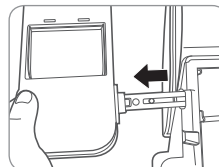

3. On the opposite side of the remote control mount rotation axis, remove the screw that fixes the axis and the cover-axis.

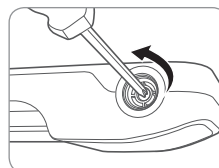

4. Remove the cover-axis from the remote control mount.

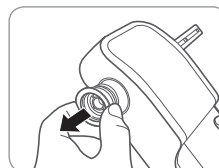

INSTALLATION

Installation the Remote Control Mount

5. Insert the rotating axis in the opposite side after pulling out it from the remote control mount.

* Insert the axis with the thicker part facing the back of the remote control mount.

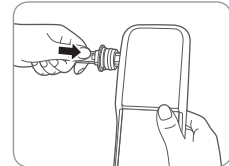
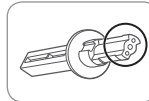

6. Insert the cover-axis in the hole on the opposite side of the rotating axis.

* Align two projections with the two grooves on the axis when inserting the cover-axis.

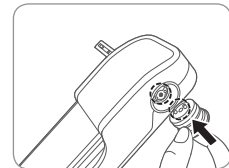

7. Fix the rotation axis and the cover-axis with a screw.

⚠ Please tighten the cover-axis firmly. If the screw is loosely assembled, the remote control mount may be separated and is dropped, which may cause product damage or a bodily injury.

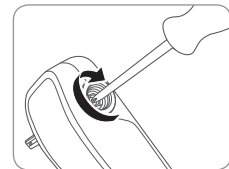

8. Please separate the rubber stopper from the opposite side of the bidet installed the remote control mount before.

* Please be sure to insert the separated rubber stopper to the opposite remote control mount fixing groove. Otherwise, the product may break.

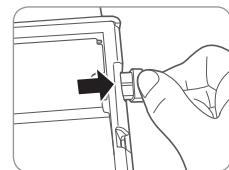

9. Insert the rotation axis of the remote control mount and fix the remote control mount with the fixing screw (Ø 6) on the bidet bottom.

⚠ Please tighten the fixing screw (Ø 6) firmly. If the screw is loosely assembled, the remote control mount may be separated and is dropped, which may cause product damage or a bodily injury.

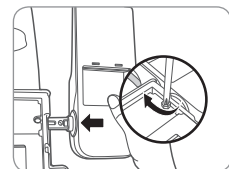



Tips

- ⚠ Install the remote control wall hanging on the wall with the screw.
The product damage or the bodily injury may be occurred due to the product falling.

Installation the Remote Control Wall Hanging

1. Put the remote control wall hanging on the wall to install the product and indicator the position to assemble the anchor (Total 3 positions).
2. Punch 3 holes with about 35 mm depth using the drill in the marked place.
* Use a drill with a diameter of \varnothing 6.5 mm.
3. Insert the concrete anchors in the drilled holes and push them through.
4. Attach it on the wall by taking off the sticker at the back of the remote control wall hanging and fixing the wall hanging hole to an anchor inserted on the wall.
5. Use it by inserting the remote control after fixing the remote control mount on the wall with a screw.

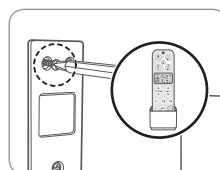
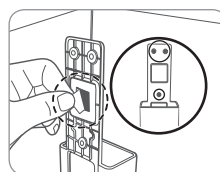
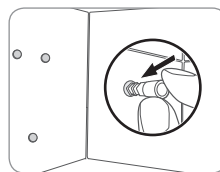
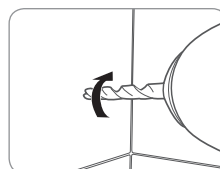
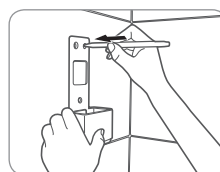

CLEANING METHOD

Nozzles



Tips

- ▶ If excessive force is exerted on the nozzle when cleaning it, the nozzle may not be working properly or be broken. Hold the nozzle lightly to clean it.
- ▶ When you clean the nozzle, the nozzle cleaning water is sprayed (But the nozzle cleaning water doesn't be sprayed and only nozzle is extended in the feed water stop status).

1. Press nozzle cleaning button on the right side of the bidet.

The nozzle cleaning water is sprayed and the front cleansing nozzle sticks out to its full length.
Clean the front cleansing nozzle.

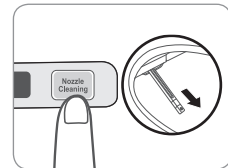

2. Press nozzle cleaning button one more.

- The nozzle cleaning water is sprayed and the front cleansing nozzle retracts itself, and the rear cleansing nozzle sticks out to its full length.
- Clean the rear cleansing nozzle.

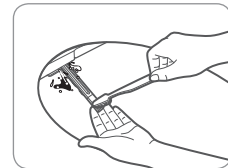

3. If you press the stop button on the remote control or nozzle cleaning button on the product once more after cleaning the rear cleansing nozzle, the nozzle cleaning water is sprayed and the rear cleansing nozzle retracts itself.

- If no button is pressed for 2 minutes after the nozzle cleaning starts, the nozzle retracts itself automatically.

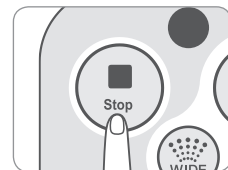

Product Body

- Apply the neutral detergent to a soft cloth or sponge and clean the product.

* If you use the detergent except for the neutral detergent, the product deformation and the damage may be occurred.

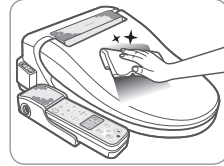

Tips



Do not use thinner, or benzene. Do not clean the product using coarse scrub or detergent with abrasives.

Uninstallation the Product

1. Unplug the power plug from the outlet.

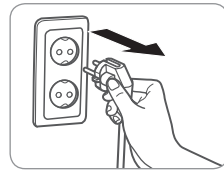

2. Close the main water supply valve.

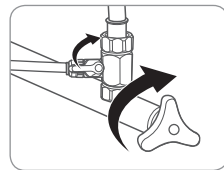

CLEANING METHOD

Uninstallation the Product

3. Place a big wash basin (1 L or more) under the rear drain hole of the bidet.

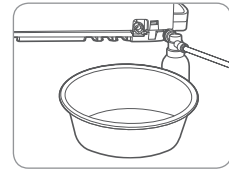

4. Turn the drain stopper to ① counter clockwise by 90° and pull out it in the direction of ② to remove it.

- Please assemble the drain stopper to the product again after draining.

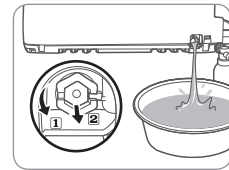

5. Please separate the product by removing the fixing nuts in the fixing screw and lifting the bidet.

- Please pull out the power plug and separate the bidet hose from T-shaped connector before separating the product.
- When storing the product, separate the filter fixed stopper and MF filter from the bidet and store them with installation materials.
- Exercise caution not to lose fixing screws and fixing nuts.

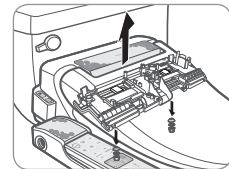

Tips

- ▶ When you don't use the product for a long time, unplug after turning off the main water supply valve and emptying the water inside the water tank.

MAINTENANCE

Freezing Protection Function

- Coway bidet has a built-in anti-freezing program. When the water temperature of the water tank falls below 5°C, the heater automatically operates to prevent freezing burst.
- * **Check that the power is turned on. If the power is turned off, the anti-freezing program does not work and the bidet may have freezing burst or malfunctions in a cold environment.**

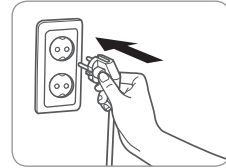

FILTER REPLACEMENT METHOD

1. Please pull out the power plug and turn off the main water supply valve.

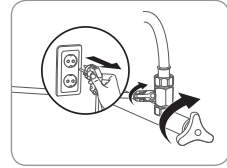

2. Separate the MF filter from the filter holder by rotating the MF filter to replace to the arrow direction.

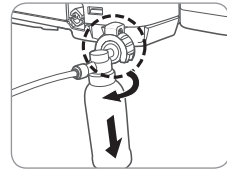

3. Please rotate and insert new MF filter to the filter holder like the next arrow direction to the end not to be shaken.

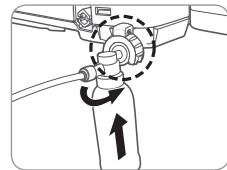

4. Use it after opening the main water supply valve and plugging in the power cord.

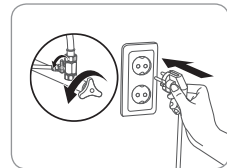

TROUBLESHOOTING

The bidet may operate abnormally due to the minor causes not because of the product malfunction but because of the fact that the user is not familiar with the product use. In such a case, problems can be solved easily even without the help from the Service Center by checking the following items. If you can't solve the problem after checking the following items, please call the Service Center.

Symptom	Check	Measures to take
The product is not working.	• Is the power plug connected to the electrical outlet?	Plug in the power cord.
	• Is it a power failure?	Check whether it is a power failure.
	• Is the control panel turned off?	Check whether buttons other than the Power button work well. If one of the other buttons is pressed down, the Power button does not work. In this case, call our service center.
Water is not ejected.	• Does the main water supply valve closed?	Open the main water supply valve.
	• Is the nozzle clogged with foreign material?	Remove the foreign material by cleaning the nozzle opening with a toothbrush.
	• After installation, water is not ejected.	Check whether the suspension of water supply is performed or not. (It takes about 1 – 2 minutes for the water tank to be filled with water after installation before water can be ejected.)
The water pressure is weak.	• Is the water pressure set too low?	Adjust the water pressure properly.
	• Is the nozzle clogged with foreign material?	Remove the foreign material by cleaning the nozzle opening with a toothbrush.
	• Is the filter clogged with foreign material?	Replace the filter correctly.
The seat and water are not warm.	• Isn't the seat and warm water temperature adjustment button set to "OFF" status?	Please adjust as the proper temperature by pressing the seat, the warm water temperature adjustment button.

TROUBLESHOOTING

Symptom	Check	Measures to take
The air from the air dryer is cold.	• Isn't the air dryer temperature adjustment button set to "OFF" status?	Please adjust as the proper temperature by pressing the air dryer temperature adjustment button.
Water leaks in areas other than the nozzles.	• Water leaks on the T-shaped connector.	Check that the rubber packing is inserted in the T-shaped connector and firmly tighten the nut again.
	• Water leaks on the connection part of the bidet hose.	Push the bidet hose to the connection part completely.
	• Water leaks on the filter.	Check whether the filter was damaged or not.
Water comes out while the bidet is not in use.	• What water comes out between the nozzles after cleansing is to clean the nozzles, not a malfunction.	
	• In some cases, water drops around the nozzles may fall down in the toilet. It is that the water drops remaining on the nozzle surface after the nozzle cleaning drop into the toilet. It is not a malfunction.	
If you plug in the power cord, the rear cleansing nozzle come out and go in.	• It is the initialization process of the nozzle position, not a product malfunction.	
There is a noise coming from the bidet.	• While the water heater is in operation, a noise is generated in a normal condition.	



Tips

- ▶ If the bidet is in power saving mode, as the seat and the warm water temperature are set to low temperature, it may be felt relatively cold when you sit on. If the bidet power saving mode is cancelled, the temperature set at the last use is maintained.
- ▶ For canceling the power saving mode, see page 10 on this manual.

SPECIFICATION

Product name		Coway Bidet
Model name		BA08-AR/AE
Power rating		220 V - 240 V~ 50 Hz, 60 Hz
Power consumption		850 W
Water pressure		0.11 MPa - 0.68 MPa
Product dimensions	BA08-AR	525 mm (W) X 500 mm (D) X 142 mm (H)
	BA08-AE	525 mm (W) X 530 mm (D) X 142 mm (H)
Weight (NET)		5.7 kg - 6.3 kg
Warm water cleansing device	Rear cleansing	Maximum 0.7 L/min, automatic nozzle cleaning function
	Front cleansing	Maximum 0.7 L/min, automatic nozzle cleaning function
	Timing	Rear cleansing 1 min, Front cleansing 1 min
	Water pressure control	Micom control, 3 level control
	Wide (spray range control)	3 level spray range control(straight-level 1-level 2)
	Air +	Air mixed water type
	Warm water temperature adjustment	4 levels (off : tap water temperature, low : 33 °C, medium : 36 °C, high : 39 °C)
	Power consumption of cistern heater	800 W
	Cistern capacity	1 L
	Safety device	Bi-metal, temperature sensor, temperature fuse(overheating prevention)
Warm air dryer	Warm air temperature control	3 levels
	Timing	Air dryer 2 min
	Power consumption of dryer heater	180 W
	Safety device	Bimetal, temperature fuse(overheating prevention)
Warm seat	Seat temperature control (after seating)	4 levels (off : room temperature, low : 34 °C, medium : 37 °C, high : 40 °C)
	Power consumption of dryer heater	50 W
	Safety device	Temperature sensor, temperature fuse(overheating prevention)
MF filter	Life span	4 months (2.5 ton/month, impurity rate : under 0.5 NTU)
	Dimension	(L) 136 mm × (Ø) 48 mm
Accessories	Installation materials	T-Shaped connector, Rubber packing, Bidet holse, 2 Fixing screws, 2 Fixing rubbers, 2 Fixing washers, 2 Fixing nuts, 2 Fixing sliders, MF filter, Filter fixed stopper, Filter clip, 3 Screws, 3 Anchors, Fixed screw(Ø6), Remote control wall hanging, Fixer hand grip, 2 Batteries(AA size)
Other function		Nozzle position adjustment, Move, Nozzle cleaning, Silent mode, Seat sensor lock, Bidet/remote control power saving mode, Remote control, Auto cleansing function
Temperature		0 °C - 40 °C

* These specifications may be changed to improve the performance of the product.

* Earlier clogging may occur in MF filter depending on quality and consumption of water.

WARRANTY CARD OR WARRANTY LETTER
ONE YEAR LIMITED WARRANTY
BIDET BA08-AR/AE ('PRODUCT')

Model:

Serial Number:

Customer Name:

("OWNER")

Date of Purchase:

What This Warranty Covers:

Commencing with the date of purchase of the Product and continuing for a period of one year, if manufacturing defects in the Product cause the Product to not operate properly for its intended use, then subject to the exclusions, conditions, and limitations contained herein, COWAY at its sole option will repair or replace the Product.

Decisions as to the extent of repair or replacement required will be made solely by COWAY.

The remedy under this Warranty is available only for that portion of the Product exhibiting defects at the time of the warranty claim. The replacement Product as well as any remaining original Product will be warranted only for the original one year warranty period. This limited warranty applies only to Product used for an application specified by COWAY for the Product and applied in strict accordance with COWAY published specifications in effect at the time of application. IF PRODUCT IS USED FOR OTHER THAN ITS INTENDED PURPOSE, IT IS SOLD AS IS AND WITHOUT ANY EXPRESS OR IMPLIED WARRANTIES, INCLUDING OF MERCHANTABILITY OR FITNESS FOR A PARTICULAR PURPOSE.

What This Warranty Does Not Cover:

This Warranty warrants that the Product will be free from manufacturing defects which affect the ability of the Product to operate for its intended use; it is not a warranty that the Product will never require repairs or to undertake responsibilities, liabilities or obligations other than those specifically identified in the preceding section. COWAY is not responsible or liable for personal injury or property damage of any kind, even if arising from a breach of this Warranty.

Limitations and Exclusions:

TO THE EXTENT PERMITTED BY APPLICABLE LAW, COWAY DISCLAIMS ANY OTHER WARRANTY EXPRESS OR IMPLIED, THAN THAT PROVIDED FOR HEREIN. THIS WARRANTY IS IN LIEU OF AND EXCLUDES ALL OTHER WARRANTIES, GUARANTEES, CONDITIONS AND REPRESENTATIONS, EXPRESS OR IMPLIED, ORAL OR WRITTEN, STATUTORY OR OTHERWISE, INCLUDING BUT NOT LIMITED TO ANY IMPLIED CONDITIONS OR WARRANTIES AS TO THE MERCHANTABILITY OR FITNESS FOR A PARTICULAR PURPOSE OF THE COWAY PRODUCT. SOME STATES DO NOT ALLOW LIMITATIONS ON HOW LONG AN IMPLIED WARRANTY LASTS, SO THE ABOVE LIMITATION MAY NOT APPLY TO YOU. COWAY DOES NOT AUTHORIZE ANY PERSON INCLUDING ITS REPRESENTATIVES, TO MAKE ANY REPRESENTATION OR TO OFFER ANY WARRANTY, CONDITION OR GUARANTY IN RESPECT OF THE PRODUCT OTHER THAN THIS WARRANTY. THIS LIMITED WARRANTY SHALL BE THE OWNER'S SOLE AND EXCLUSIVE REMEDY AGAINST COWAY AND COWAY SHALL NOT BE LIABLE FOR ANY CONSEQUENTIAL, EXEMPLARY, SPECIAL, INCIDENTAL OR OTHER DAMAGES INCLUDING, BUT NOT LIMITED TO, LOSS OF PROFITS, AND LOSS OF USE. INCIDENTAL, CONSEQUENTIAL AND EXEMPLARY DAMAGES SHALL NOT BE RECOVERABLE EVEN IF THE REMEDIES OR THE ACTIONS PROVIDED FOR IN THIS WARRANTY FAIL OF THEIR ESSENTIAL PURPOSE. SOME STATES DO NOT ALLOW THE EXCLUSION OR LIMITATION OF INCIDENTAL OR CONSEQUENTIAL DAMAGES, SO THE ABOVE LIMITATION OR EXCLUSION MAY NOT APPLY TO YOU. COWAY SHALL NOT BE LIABLE FOR ANY DAMAGES WHICH ARE BASED UPON NEGLIGENCE, BREACH OF WARRANTY, STRICT LIABILITY OR ANY OTHER LEGAL THEORY OF LIABILITY OTHER THAN THE EXCLUSIVE LIABILITY SET FORTH IN THIS WARRANTY.

Limitations on Implied Warranties:

Any implied warranty of merchantability or fitness for a particular purpose or use, shall be limited to the duration of the foregoing express written warranty.

Conditions of Warranty:

COWAY's continuing liability under this Warranty is conditioned upon the following:

- a) The defect or damage is not caused by or is the result of: abnormal use or conditions; improper storage, unauthorized modifications or repair; misuse, neglect, accident, alteration, improper installation or other acts that are not the fault of Coway or the manufacturer of the product or that are not covered by the manufacturer's warranty;
- b) The Product has not been altered, modified or repaired without prior written approval of COWAY;
- c) The OWNER has notified COWAY in writing of any failure of the Product covered by this Warranty within thirty (30) days following such failure;
- d) There has been no misuse, abuse or negligence with respect to the Product on the part of the OWNER.

Our goods come with guarantees that cannot be excluded under the Australian Consumer Law.

You are entitled to a replacement or refund for a major failure and for compensation for any other reasonably foreseeable loss or damage.

You are also entitled to have the goods repaired or replaced if the goods fail to be of acceptable quality and the failure does not amount to a major failure.

Waiver:

COWAY's failure at any time to enforce or rely upon any of the terms or conditions stated herein shall not be construed to be a waiver of its rights hereunder.

Obtaining Warranty Service and OWNER'S Duties:

If the Product fails to operate for its intended purpose, then notify COWAY or its Representative Agency, within 48 hours or within the next business day after discovery of any defect in the Product. The OWNER must give written notice to COWAY no later than thirty (30) days after a defect is discovered or should by reasonable diligence have been discovered. Claims under this Warranty will require proof of purchase by the OWNER.

MADE IN KOREA

001
1209542

coway

www.coway.com